

PARTICOLARE ALLACCIO IDRICO SINGOLO A PARETE
DETAGLIO PEZZI SPECIALI E VALVOLE

TUBO DIMENSIONI, CONTATORE E SPORTELLO

| TIPOLOGIA | PROTEZIONE |
|-----------|------------|
| 1 | 1 |
| 2 | 2 |
| 3 | 3 |
| 4 | 4 |

CONTORE
1/2"

CONSIGLIO ALTO
100 x 100

91-180

5,50
0,50
0,40
0,20
0,20
0,20

Se. n. 2 (dimensioni: 0,20 x 0,20 x 0,20) n

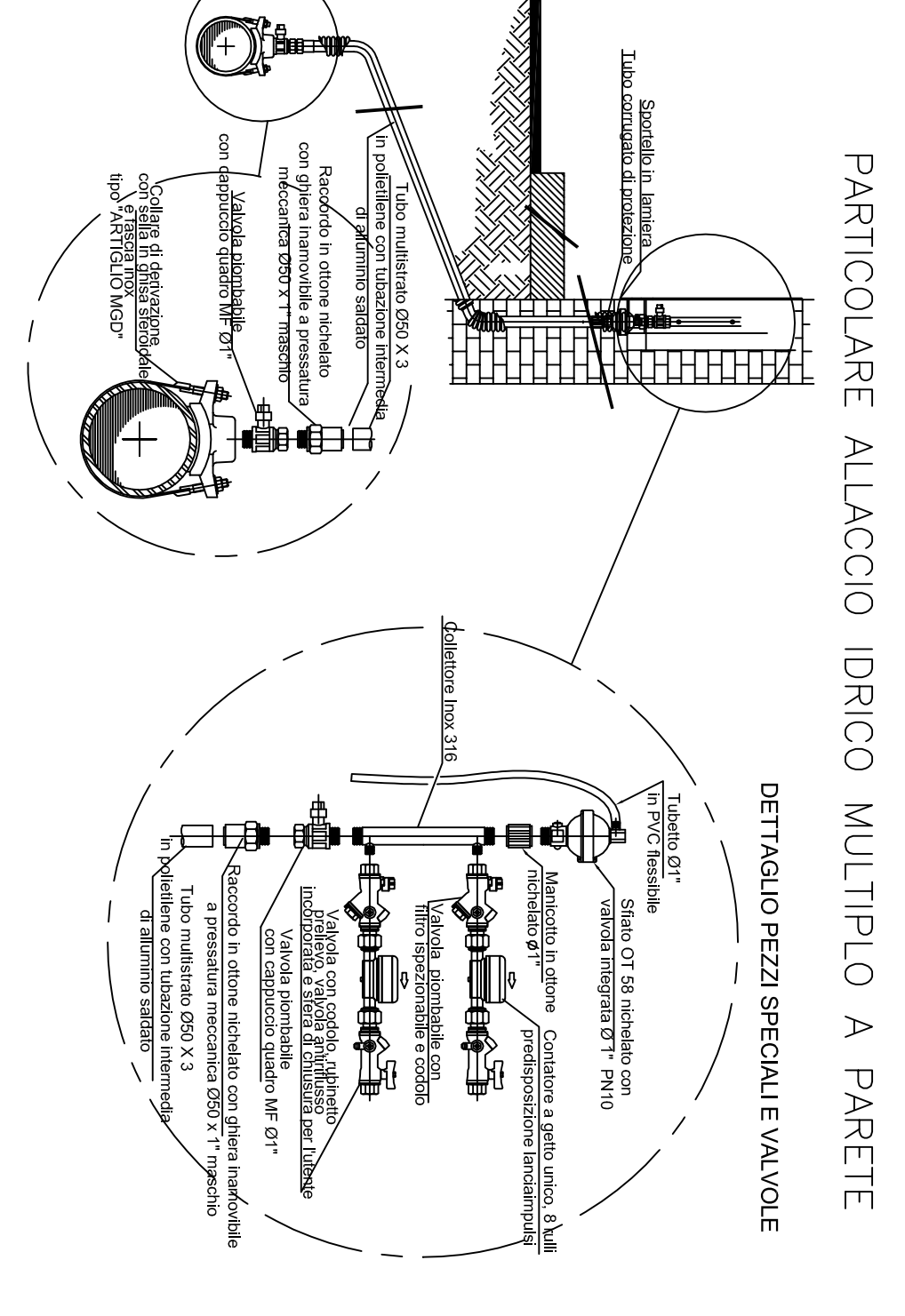

PARTICOLARE ALLACCIO IDRICO MULTIPLO A PARETE
DETAGLIO PEZZI SPECIALI E VALVOLE

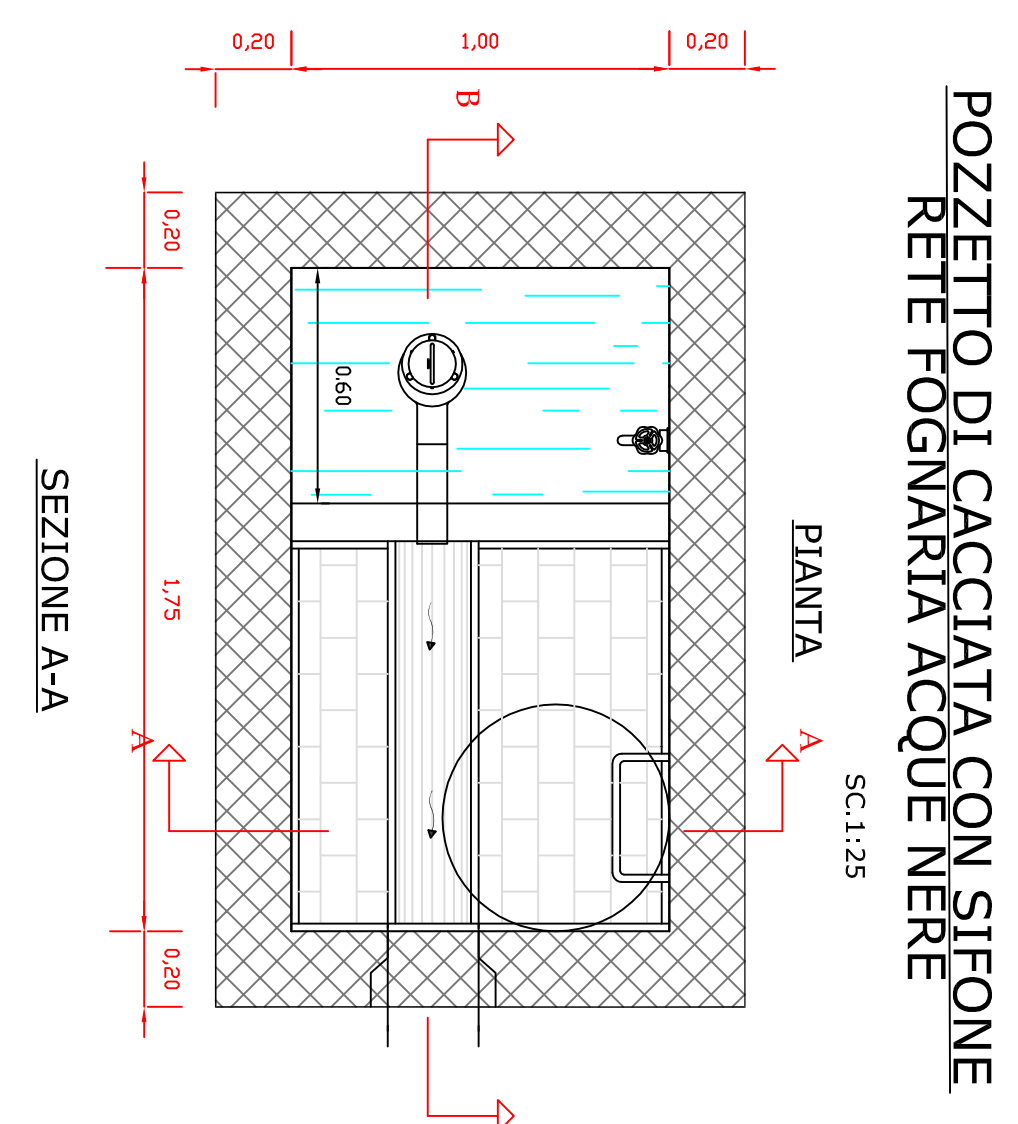

POZZETTO DI CACCIATA CON SIFONE
RETE FOGNARIA ACQUE NERE

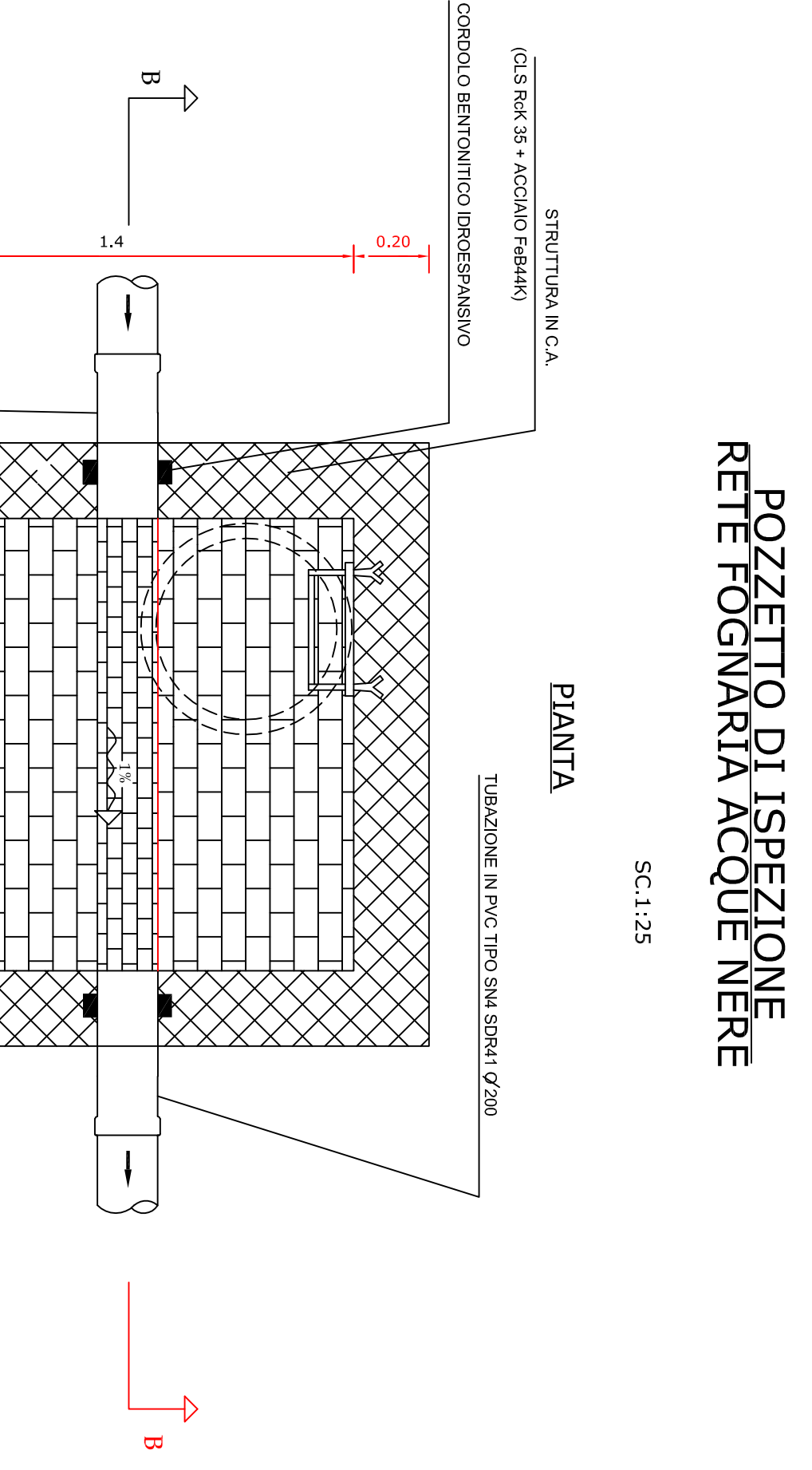

POZZETTO DI ISPEZIONE
RETE FOGNARIA ACQUE NERE

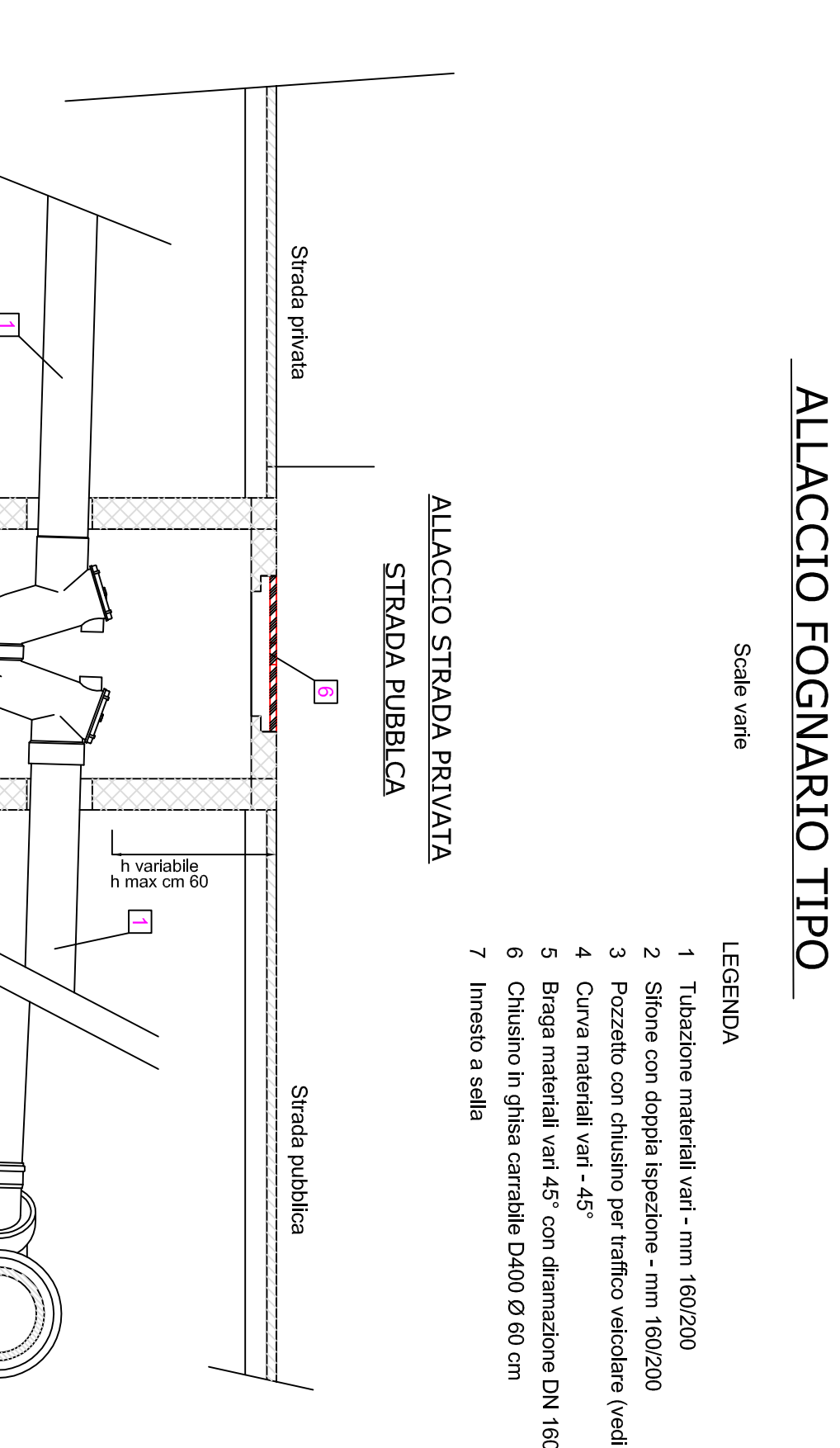

ALLACCIO FOGNARIO TIPO

- Scale varie
- LEGENDA
1. Tubazione metallica vas. - mm. 160/200
 2. Sifone con doppia sifone - mm. 160/200
 3. Pozzetto con orlino per rifinito verticale (vedi disegno)
 4. Cura materiale vas. - 45°
 5. Brigaio in ghisa smaltata DN 160/200
 6. Chiusura in ghisa smaltata DN 160/200
 7. Innesco a sfera



COMUNE DI ORISTANO

PROVINCIA DI OR

PROGETTAZIONE URBANISTICA

PIANO DI LOTTIZZAZIONE "CHIRIGHEDDU"

PROGETTO ESECUTIVO



TAVOLA 11
PARTICOLARE COSTRUTTIVI
RETE IDRICA E FOGNATURE ACQUE NERE



Completare:
Raimondo MUGHERDU
Andrea MANICA
Laura SCHINTU
Fabrizio CROBU
Renzo LEDDA
Ivo BULEGAS



Progettare:
Dario Gion, Valpiero E. DELUGAS



Responsabile dell'Urbanistica:
Ing. Michele SCANU

Data: APRILE 2014

Sindaco:
Guido TENNAS

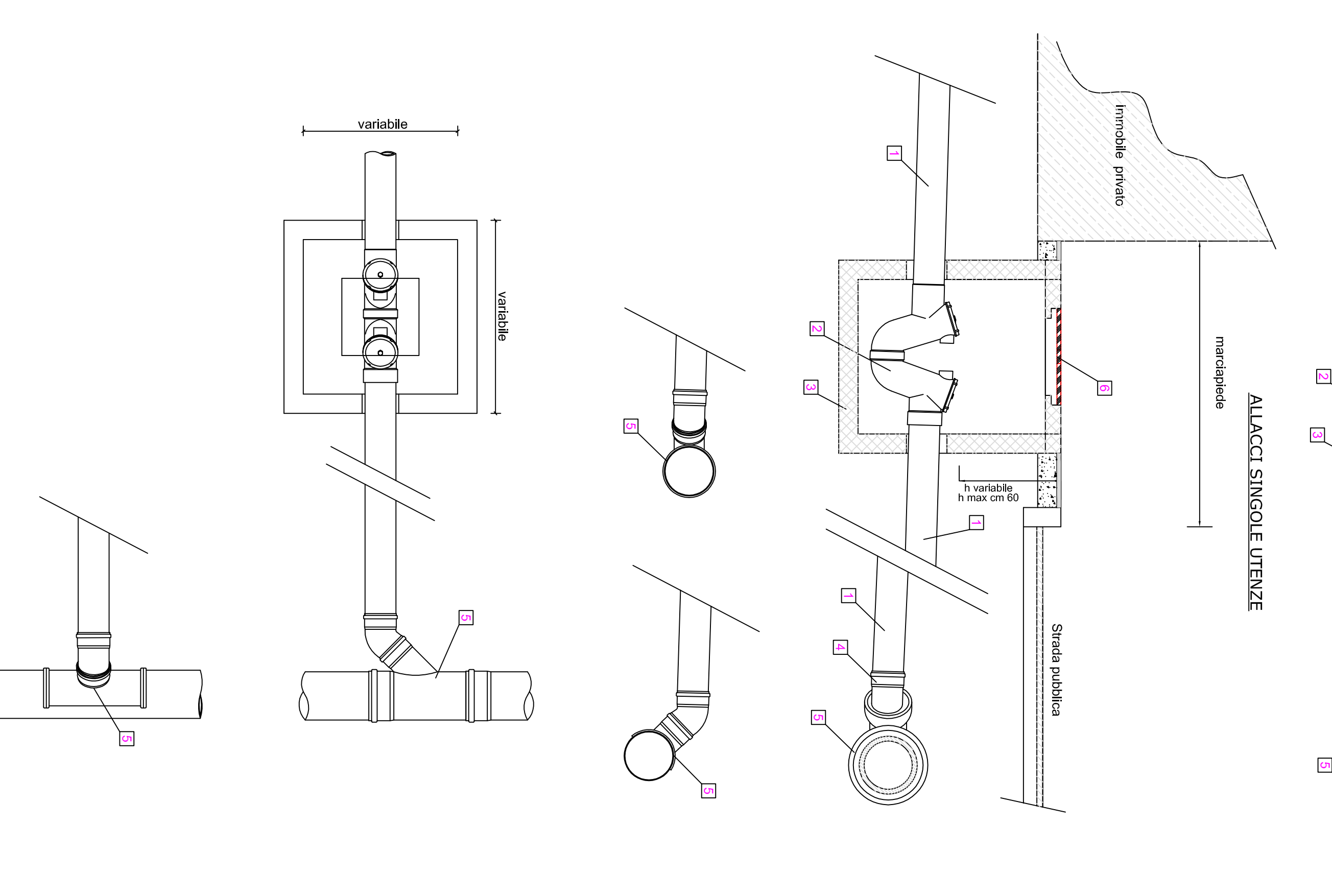
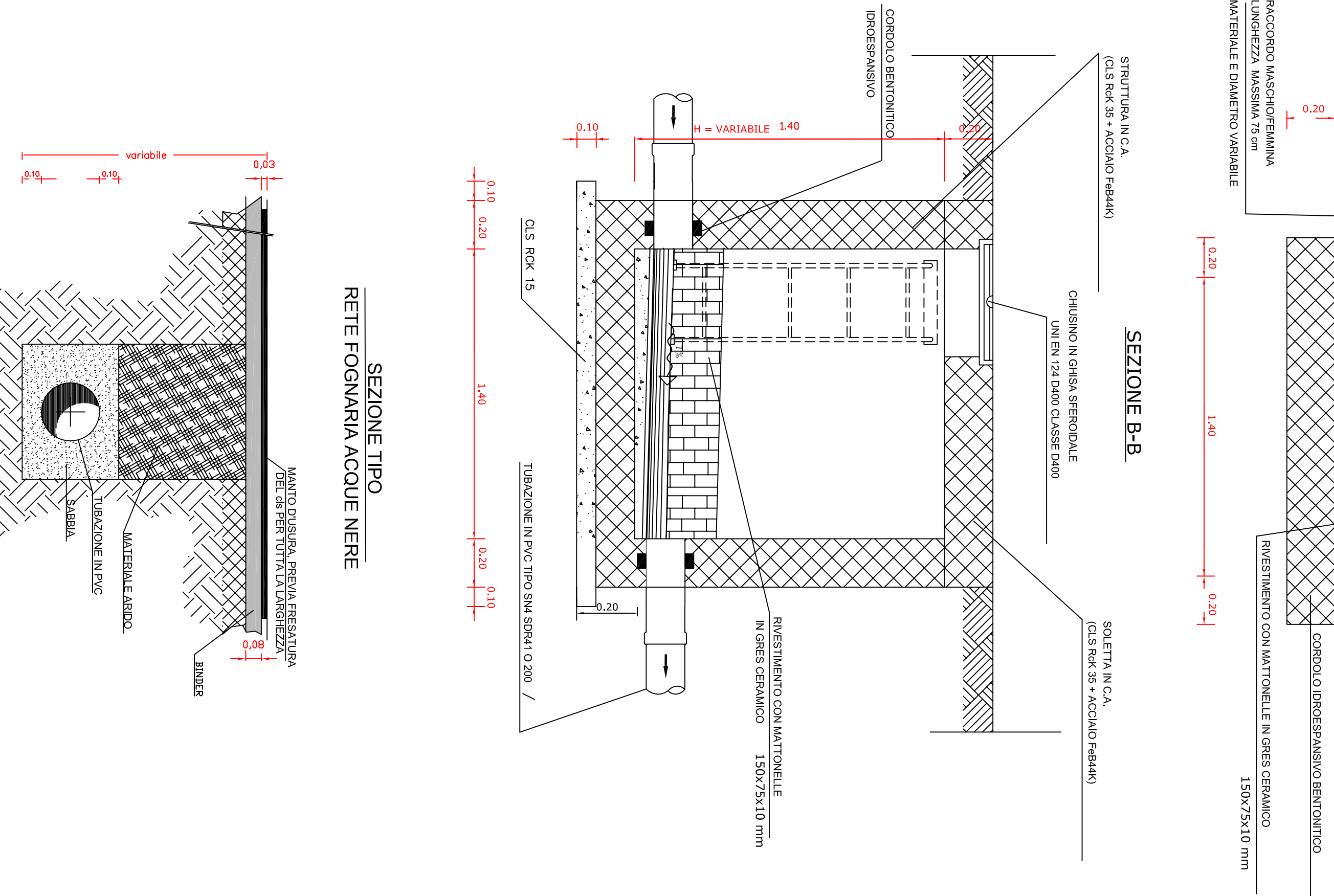
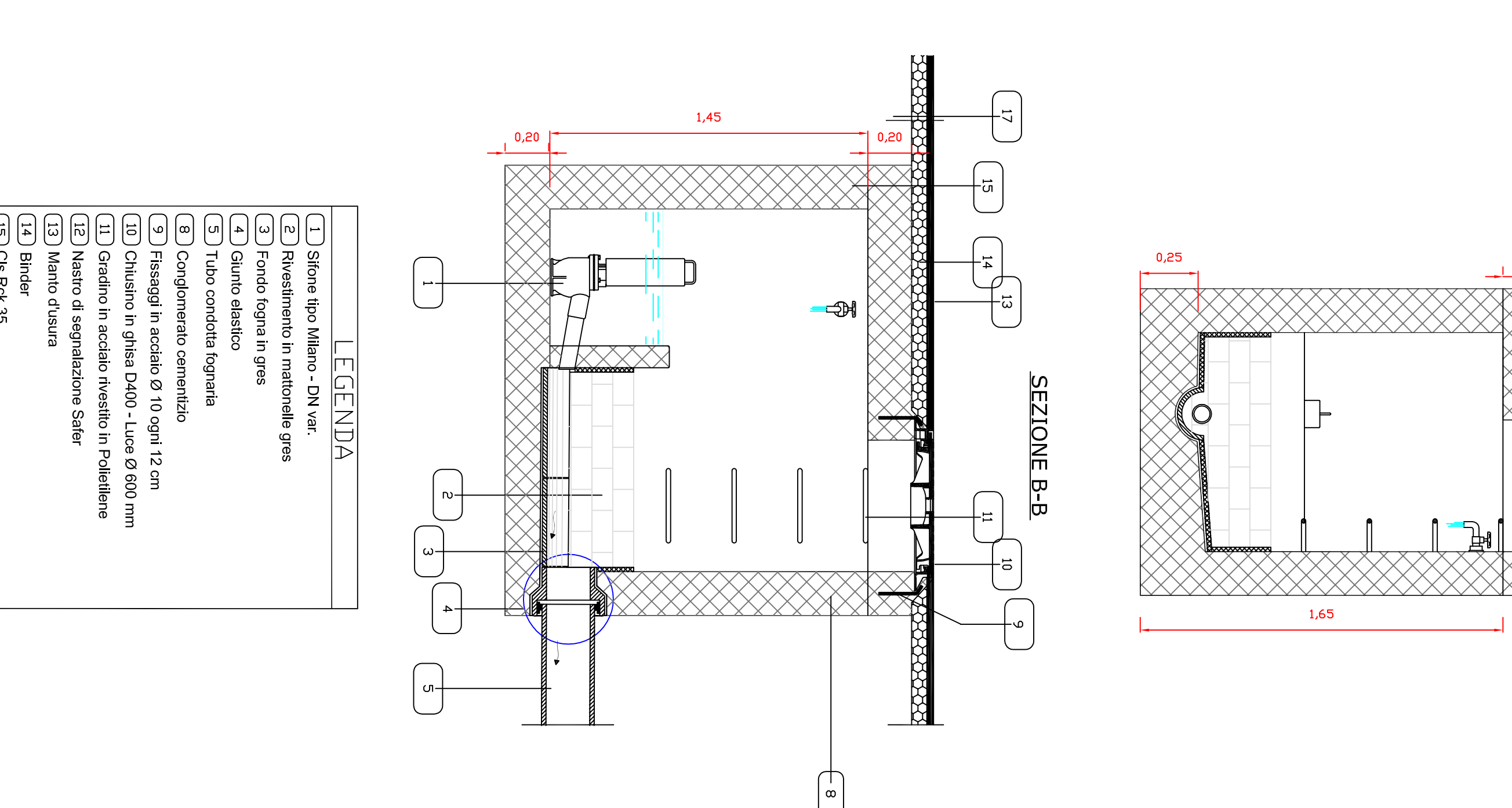
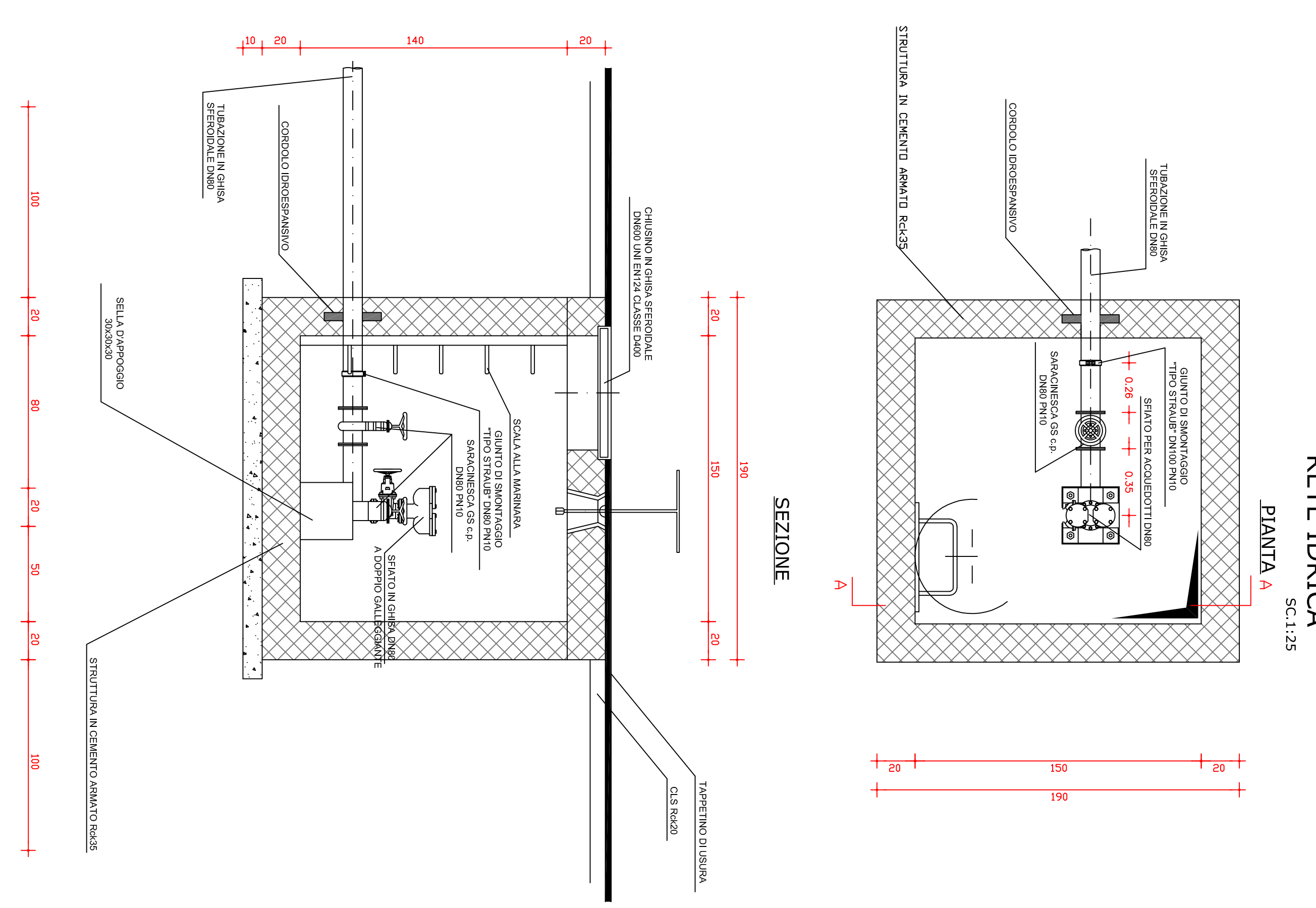

SC.1:25